

NOZZLE SCHEDULE & ACCESSORIES					
SERVICE	STOCK NO.	SIZE	FITTING	DEG	ELEV

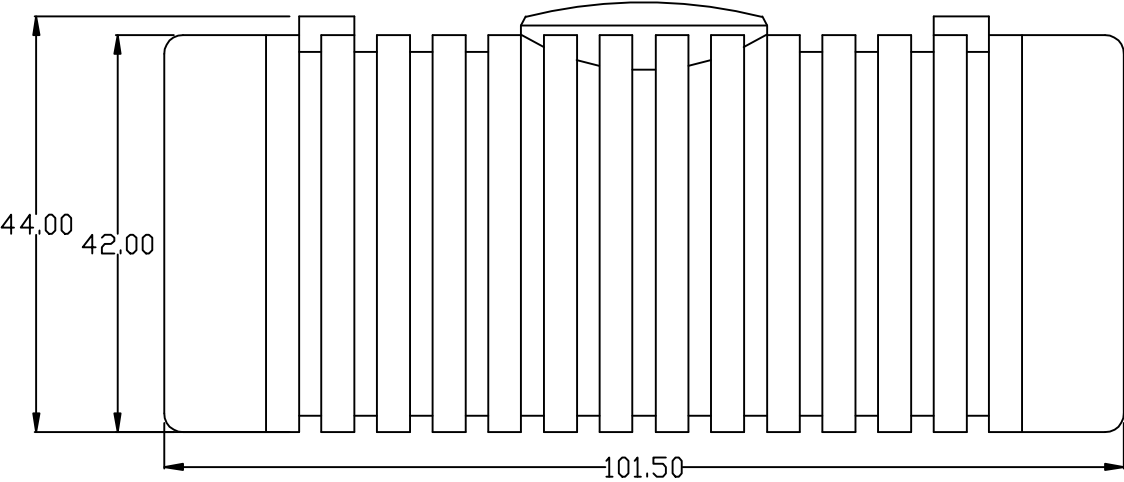
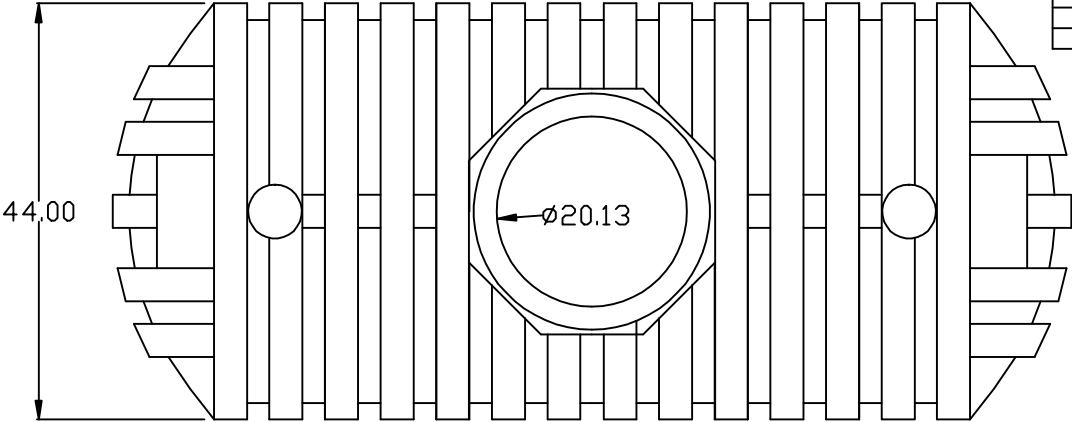

- NOTES**
1. THIS IS A COMPUTER GENERATED DWG. DO NOT REVISE BY HAND.
 2. DIMENSIONS WILL VARY ±3% DUE TO VARIATIONS IN MULTIPLE MOLDS & CONDITIONS PREVALENT DURING MANUFACTURE & USAGE.
 3. MATERIAL OF CONSTRUCTION - HIGH DENSITY POLYETHYLENE
 4. TANK RATING - 1.5 SPECIFIC GRAVITY
 5. VOLUME - 600 U.S. GALLONS

DWG TITLE				
BELOW GROUND CISTERN CIS600				
SCALE: NTS	DYNAMIC PLASTIC SOLUTIONS INC.			DR: DTI
DATE: 27/07/09	1-866-559-2357			CK:
PROJECT:	SHEET	COMPUTER FILE	REV	
PLASTIC CISTERN TANK	1 OF 1	CIS600		