

NOZZLE SCHEDULE & ACCESSORIES				
SERVICE	STOCK NO.	SIZE	FITTING	ELEV

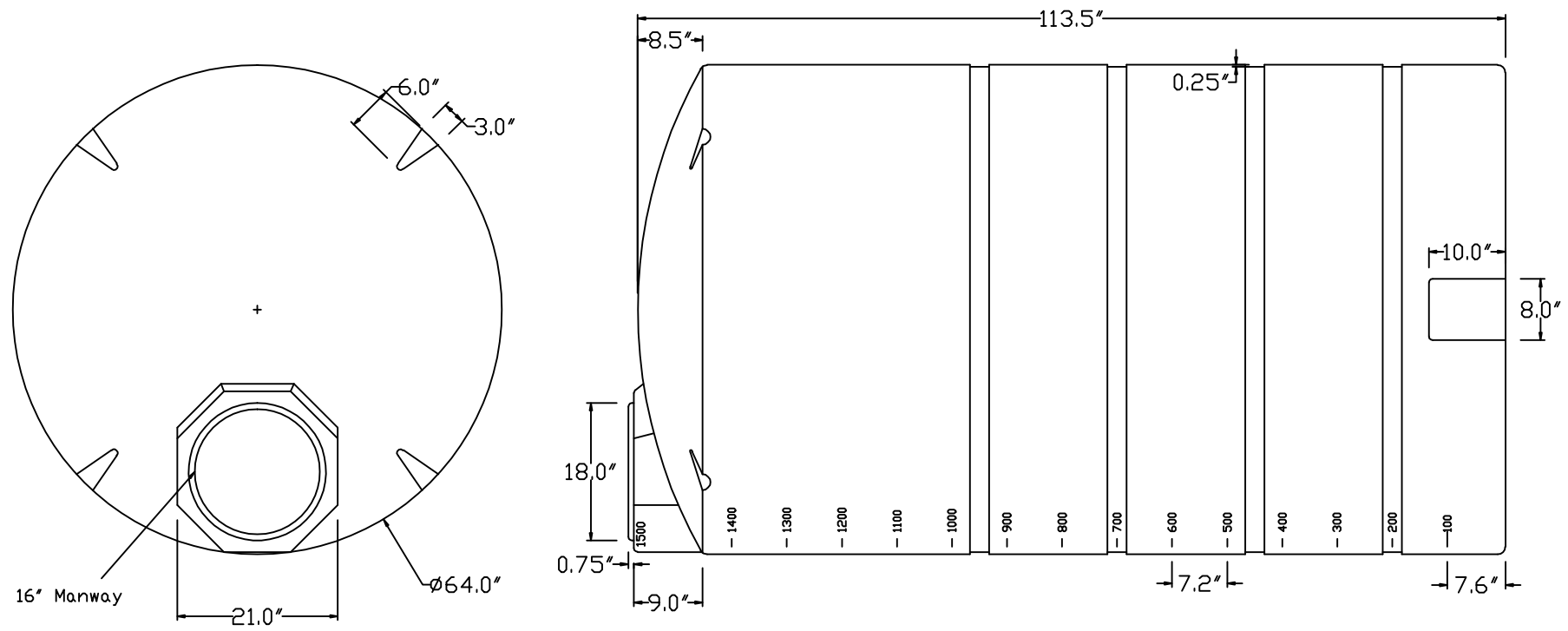

- NOTES**
1. THIS IS A COMPUTER GENERATED DWG. DO NOT REVISE BY HAND.
 2. DIMENSIONS WILL VARY ±3% DUE TO VARIATIONS IN MULTIPLE MOLDS & CONDITIONS PREVALENT DURING MANUFACTURE & USAGE.
 3. MATERIAL OF CONSTRUCTION - HIGH DENSITY POLYETHYLENE
 4. TANK RATING 1.5 SPECIFIC GRAVITY
 5. VOLUME 1500 U.S. GALLON

DWG TITLE			
ABOVE GROUND VERTICAL TANK 1500 U.S. GALLONS			
SCALE:	DYNAMIC PLASTIC SOLUTIONS INC.		DR:
DATE: 2/16/08	1-866-559-2357		CK:
PROJECT:	SHEET	COMPUTER FILE	REV
SS1500	1 OF 1	SS1500	