

NOZZLE SCHEDULE & ACCESSORIES				
SERVICE	STOCK NO.	SIZE	FITTING	ELEV

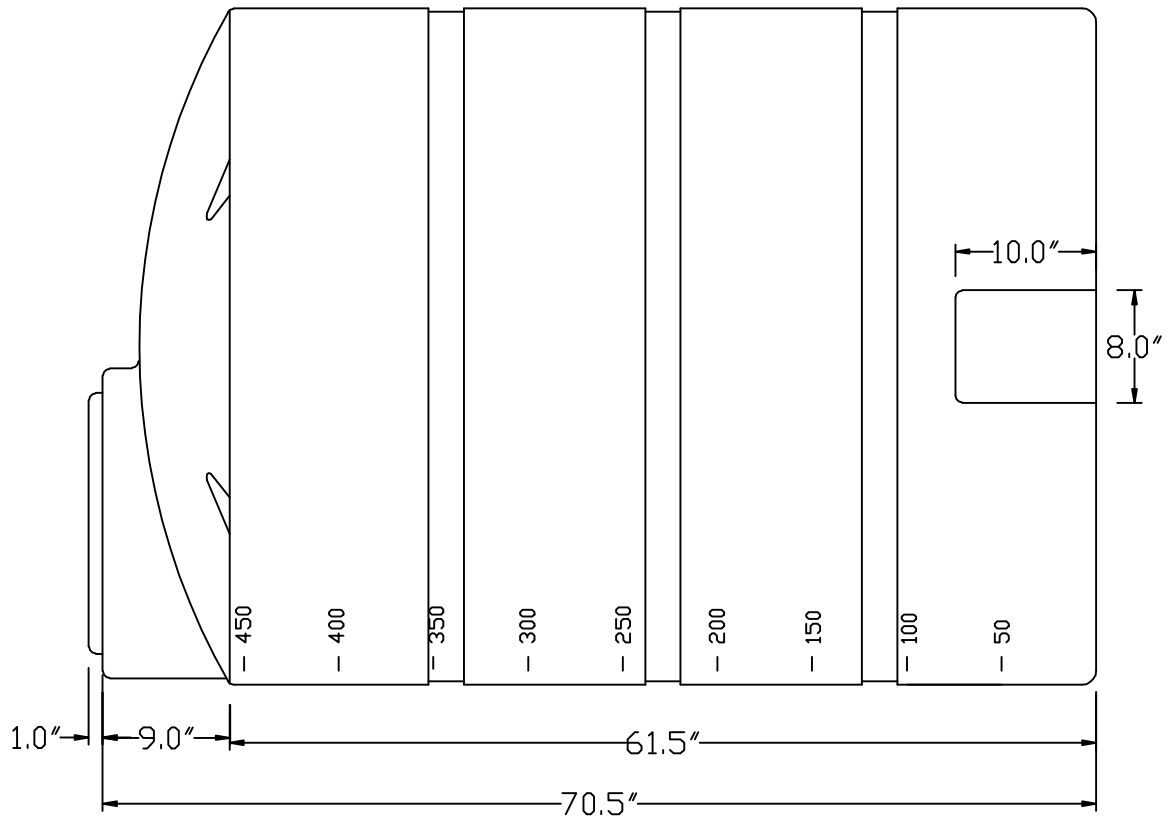
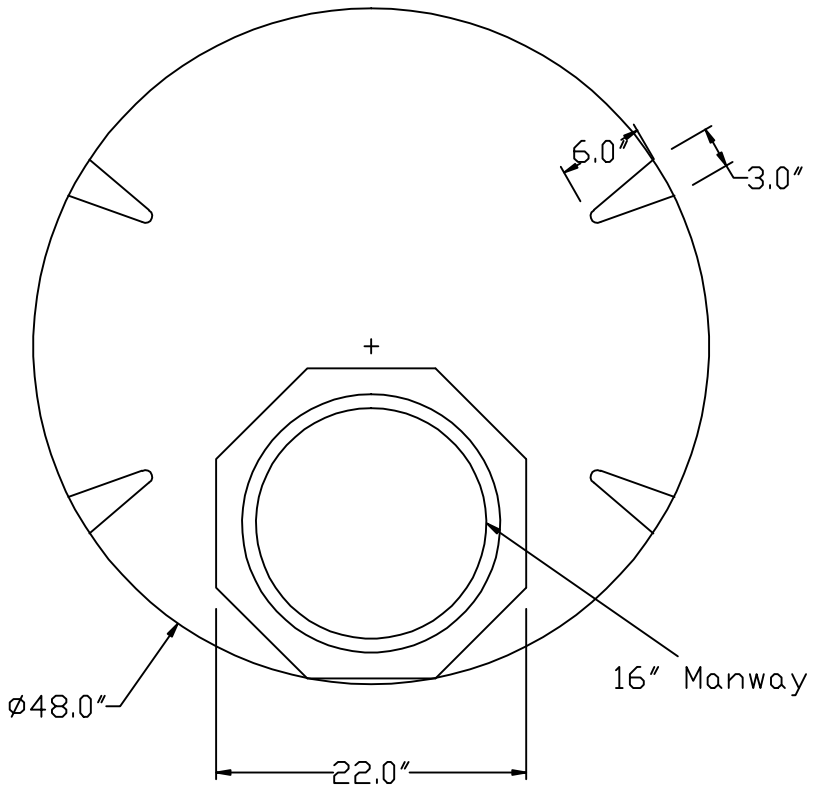

NOTES

1. THIS IS A COMPUTER GENERATED DWG. DO NOT REVISE BY HAND.
2. DIMENSIONS WILL VARY ±3% DUE TO VARIATIONS IN MULTIPLE MOLDS & CONDITIONS PREVALENT DURING MANUFACTURE & USAGE.
3. MATERIAL OF CONSTRUCTION - HIGH DENSITY POLYETHYLENE
4. TANK RATING 1.5 SPECIFIC GRAVITY
5. VOLUME 500 U.S. GALLON

DWG TITLE			
ABOVE GROUND VERTICAL TANK 500 U.S. GALLONS			
SCALE:	DYNAMIC PLASTIC SOLUTIONS INC.		DR:
DATE: 2/15/08	1-866-559-2357		CK:
PROJECT:	SHEET	COMPUTER FILE	REV
UCT500	1 OF 1	UCT500	