

NOZZLE SCHEDULE & ACCESSORIES				
SERVICE	STOCK NO.	SIZE	FITTING	ELEV

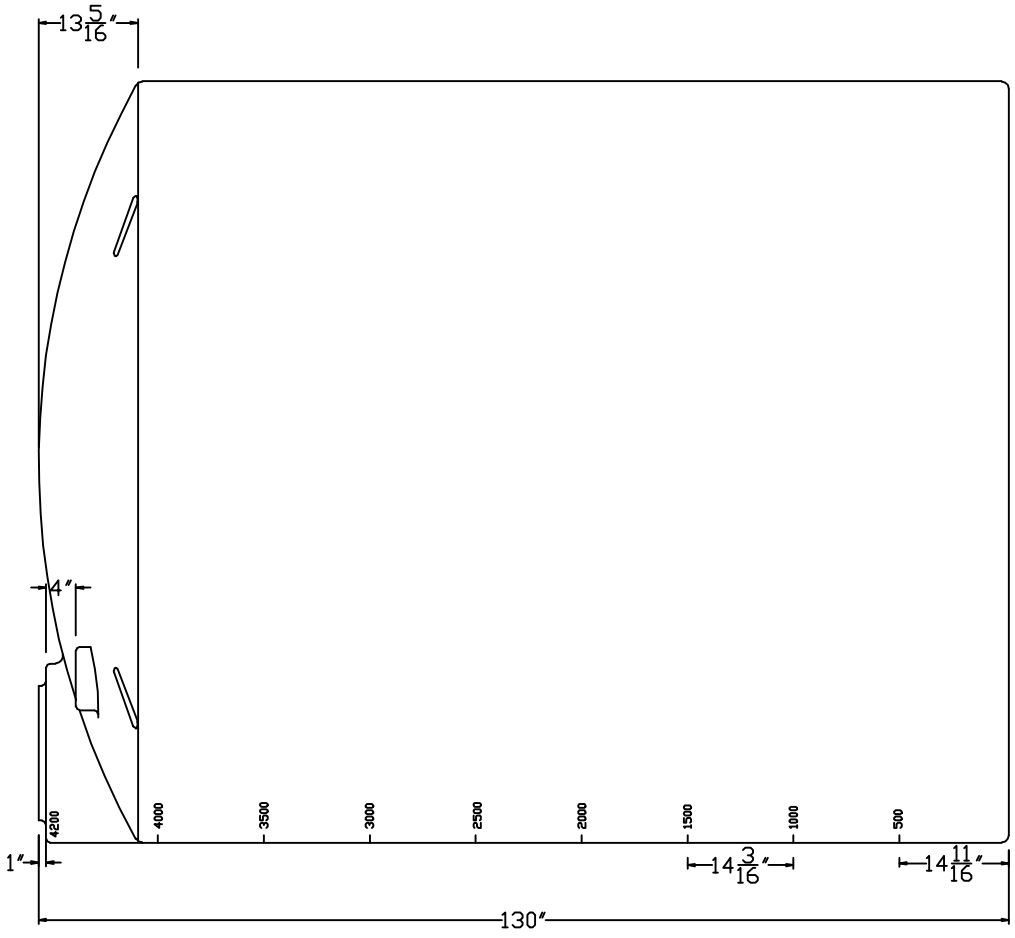
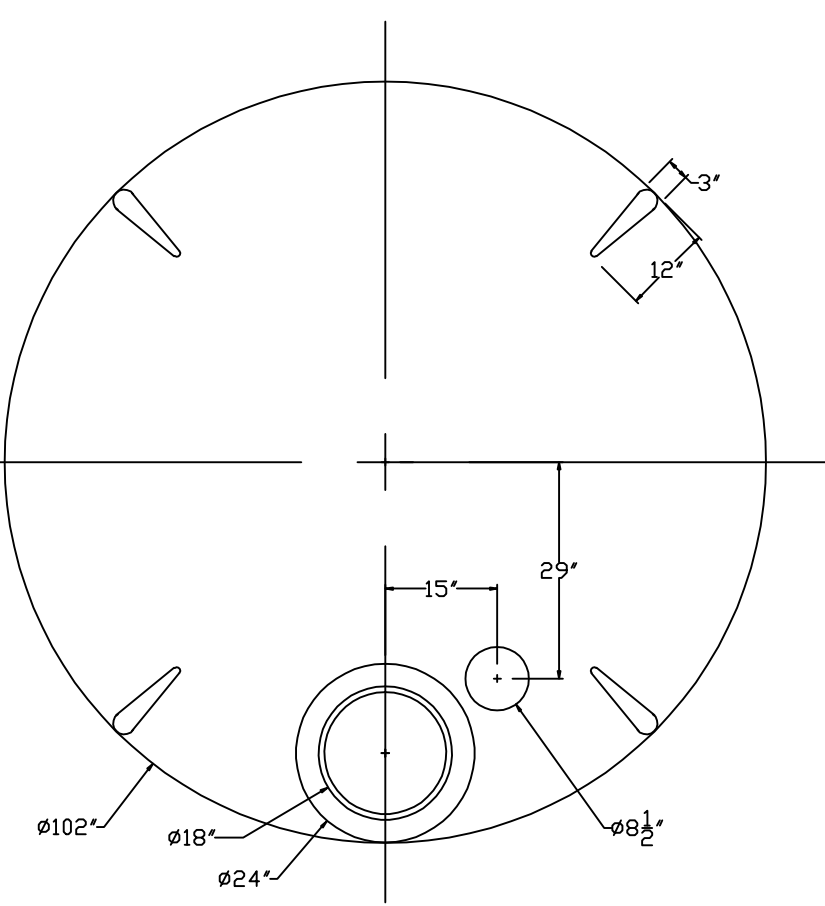

- NOTES**
1. THIS IS A COMPUTER GENERATED DWG. DO NOT REVISE BY HAND.
  2. DIMENSIONS WILL VARY  $\pm 3\%$  DUE TO VARIATIONS IN MULTIPLE MOLDS & CONDITIONS PREVALENT DURING MANUFACTURE & USAGE.
  3. MATERIAL OF CONSTRUCTION - HIGH DENSITY POLYETHYLENE
  4. TANK RATING 1.5 SPECIFIC GRAVITY
  5. VOLUME 4200 U.S. GALLON

DWG TITLE			
ABOVE GROUND VERTICAL TANK 4200 U.S. GALLONS			
SCALE:	DYNAMIC PLASTIC SOLUTIONS INC.		DR:
DATE: 2/18/08	1-866-559-2357		CK:
PROJECT:	SHEET	COMPUTER FILE	REV
UCT4200	1 OF 1	UCT4200	